

**AUDIOCENTER**

Dynamic Audio Solutions

## **VA Series**

**PROFESSIONAL POWER  
AMPLIFIERS**

# **OWNER'S MANUAL**



Revision A4-2014-05

[www.ac-pro.net](http://www.ac-pro.net)    [info@ac-pro.net](mailto:info@ac-pro.net)

# Important Precautions

---



This symbol is used to alert the operator to follow important operating and precautions detailed in documentation.



This symbol is used to warn operators that uninsulated "dangerous voltages" are present within the equipment enclosure that may pose a risk of electric shock.

1. Save the carton and packing material even if the equipment has arrived in good condition. Should you ever need to ship the unit, use only the original factory packing.
2. Read all documentation before operating your equipment. Retain all documentation for future reference.
3. Follow all instructions printed on unit chassis for proper operation.
4. Do not spill water or other liquids into or on the unit, or operate the unit while standing in liquid.
5. Make sure power outlets conform to the power requirements listed on the back of the unit.
6. Do not use the unit if the electrical power cord is frayed or broken. The power supply cords should be routed so that they are not likely to be walked on or pinched by items placed upon or against them, paying particular attention to cords and plugs, convenience receptacles, and the point where they exit from the appliance.
7. Always operate the unit with the AC ground wire connected to the electrical system ground. Precautions should be taken so that the means of grounding of a piece of equipment is not defeated.
8. Mains voltage must be correct and same as that printed on the rear of the unit. Damage caused by connection to improper AC voltage is not covered by any warranty.
9. Have gain controls on amplifiers turned down during power-up to prevent speaker damage if there are high signal levels at the inputs.
10. Power down and disconnect units from mains voltage before making connections.

11. Never hold a power switch in the "ON" position if it won't stay there itself!

12. Do not use the unit near stoves, heat registers, radiators, or other heat producing devices.

13. Do not block fan intake or exhaust ports. Do not operate equipment on a surface or in an environment which may impede the normal flow of air around the unit, such as a bed, rug, weather sheet, carpet, or completely enclosed rack. If the unit is used in an extremely dusty or smoky environment, the unit should be periodically "blown free" of foreign matter.

14. Do not remove the cover. Removing the cover will expose you to potentially dangerous voltages. There are no user serviceable parts inside.

15. Connecting amplifier outputs to oscilloscopes or other test equipment while the amplifier is in bridged mode may damage both the amplifier and test equipment!

16. Do not drive the inputs with a signal level greater than that required to drive equipment to full output.

17. Do not connect the inputs / outputs of amplifiers or consoles to any other voltage source, such as a battery, mains source, or power supply, regardless of whether the amplifier or console is turned on or off.

18. Do not run the output of any amplifier channel back into another channel's input. Do not parallel- or series-connect an amplifier output with any other amplifier output. **Audiotronics** is not responsible for damage to loudspeakers for any reason.

19. Do not ground any red ("hot") terminal. Never connect a "hot" (red) output to ground or to another "hot" (red) output!

20. Non-use periods. The power cord of equipment should be unplugged from the outlet when left unused for a long period of time.

21. Service Information. Equipment should be serviced by qualified service personnel when:

- A. The power supply cord or the plug has been damaged;
  - B. Objects have fallen, or liquid has been spilled into the equipment;
  - C. The equipment has been exposed to rain;
  - D. The equipment does not appear to operate normally, or exhibits a marked change in performance;
  - E. The equipment has been dropped, or the enclosure damaged.
22. To obtain service, contact your nearest **Audiotronics** Service Center, Distributor, Dealer.

## Table of Contents

Introduction	2
Unpacking	2
Installation and Mounting	2
Front View	3
Rear&Side Views	4
Front panel	5
Rear panel	6
Operation	7
Mods Selection	8
Stereo/Paralle/Bridged Mode Connections	9
Protection Features	10
User Precautions	11
Speaker Protection	11
Recommended Speaker Cabling	11
Maintenance	12
User Responsibility	12
Service and Repair	12

Appendix A  
Appendix B  
Appendix C

Specifications  
VA Block Diagram  
Wire Gauge Charts



## Introduction

Congratulations on your purchase of a new VA Series professional power amplifier, and thank you for your confidence in **AUDIOCENTER** products. You are among the growing number of audio professionals who have made **AUDIOCENTER** one of the world's leading suppliers of professional and commercial/industrial audio systems.

For your safety, please read the Important Precautions section before installing and operating the amplifier. The **AUDIOCENTER** VA Series is based on the same advanced circuit topologies that have made **AUDIOCENTER** amplifiers the choice of touring professionals worldwide. VA Series amplifiers are designed for high operating efficiency and accurate sonic performance across the full audio bandwidth, even under stressful conditions. In order to maintain strict quality assurance standards, all VA Series amplifiers are built in **AUDIOCENTER**'s state-of-the-art European manufacturing facility. Internal components are the finest available, and key sub assemblies are pre-tested before final assembly. Finally, each amplifier is "burned in" and thoroughly tested (using precision audio test equipment) before shipping. In addition, all VA Series amplifiers incorporate **AUDIOCENTER**'s exclusive TourClass protection features to safeguard both internal circuitry and connected loudspeakers. This proven combination of advanced design, quality structure, and comprehensive circuit protection is your guarantee of fail-safe reliability. You can depend on consistent, stable performance even when your VA Series amplifier is subjected to punishing extremes in the most demanding fixed or mobile sound reinforcement applications.

## Unpacking

Please inspect the amplifier carefully immediately after unpacking. If you find any damage, notify your supplier/dealer immediately. Only the shipper may file a damage claim with the carrier for damage incurred during shipping. Be sure to save the carton and all packing materials for the carrier's inspection. If your packing materials are in good condition, please save them. If you ever need to ship the unit back to **AUDIOCENTER** or an authorized service center, you should use only the original factory packing.

## Installation and Mounting

VA201 is 1-rack-space high, VA401, VA601, VA801 are 2-rack-space high and VA1201 are 3-rack-spaces high. All mount in standard 19-inch Racks. four front-panel mounting holes are provided on each amplifier. Rear mounting ears give additional support, and use of rear supports is highly recommended in all mobile and touring sound systems.

**Front View**

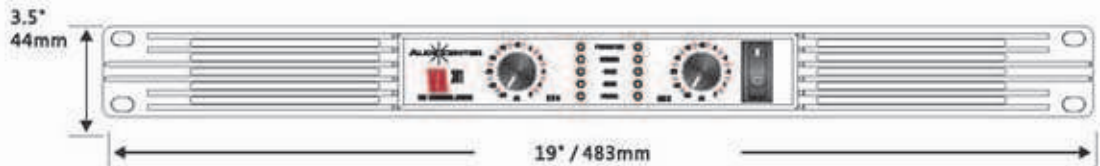

**Rear & Side Views**

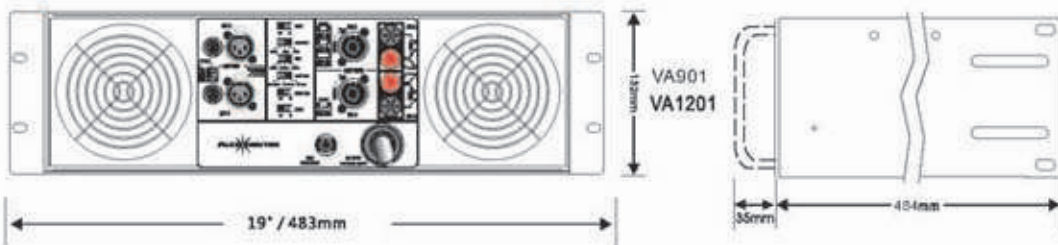
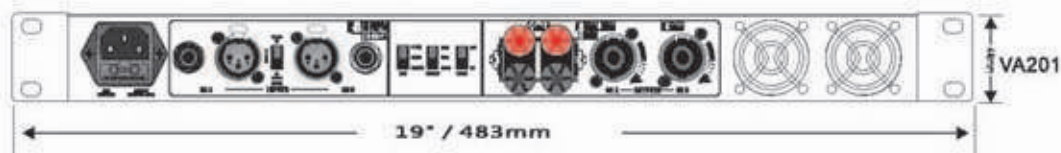

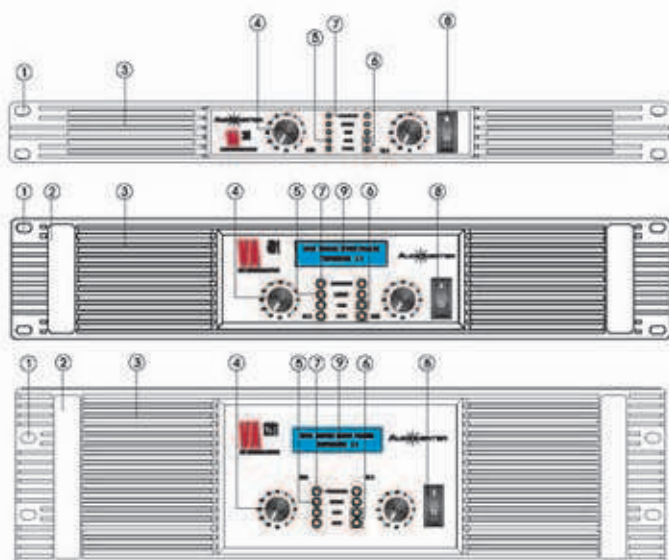
**1. Rack Mounting Ears.**

Two front panel mounting holes are provided on each mounting ear.

**2. Rack Handles.**
**3. Fan Outlet Grills.**

VA Series amplifiers are cooled by two, rear-mounted fans. Cool air flows over the heat sinks and exhausts through the front grills. Make sure these outlets remain clean to allow unrestricted air flow.

**4. Input Attenuators.**
**5. Limiter LED.**

Illuminates at the clipping threshold. Continuous illumination also indicates that ACL (Active Clip Limiting) protection circuitry is engaged.

**6. Signal LED.**

Illuminates to indicate that a signal (above a minimum threshold) is present at the amplifier input, and that the signal is being amplified.

**7. Protect LED.**

Indicates that the channel is in Protect mode (speakers disconnected by output relay). The light is white.

**8. AC Power Switch/Circuit Breaker.**

All amplifiers have a front-panel combination of AC switch and circuit breaker. (No fuse is used.) If the switch shuts off during normal use, push it back to the "ON" position once. If it will not stay on, the amplifier needs servicing.

**9. LCD display**

Shows the working mode, protection status and temperature of the modules.



*Never try to hold the circuit breaker/power switch in the "ON" position if it won't stay there itself!*

## Rear Panel

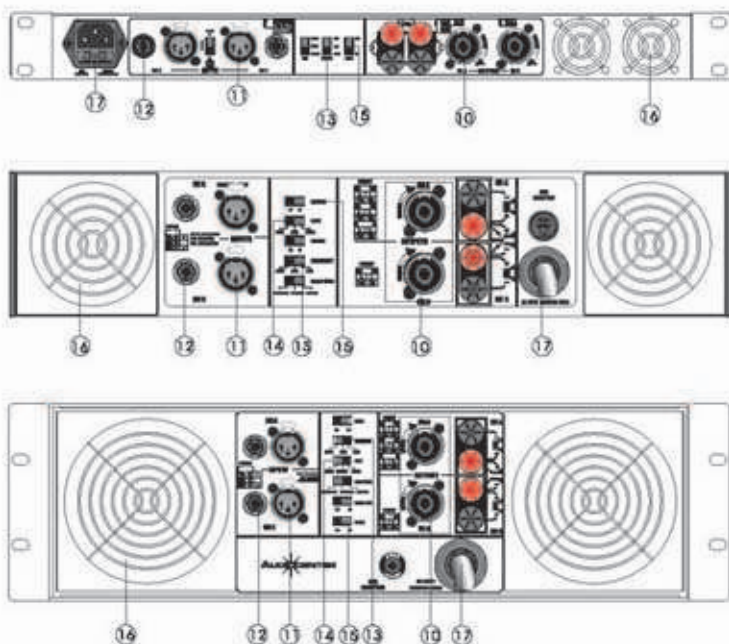

### 10. Output Connectors

Using speakon-type speaker cables, make connections to both the channel A and channel B connectors for stereo or parallel mode. or to the bridged mode connector for bridged mono mode, see the section on mode selection for more information.

### 11-12. XLR Input Connectors

These connectors accept input signals on balanced male and female XLR input plugs. Connectors for each channel are in parallel; the unused connectors may be used for "loop Through" Connection to other amplifiers.

### 13. Input sensitivity selector

This selector allows to choose the input sensitivity.

### 14. Mode Selection Switch

This DIP switch configures the Amplifier for Stereo, Parallel or Bridged Mono Mode operation. Amplifiers are factory-configured for stereo Mode.

### 15. Filter 100Hz select:

Subwoofer, Full range, Satellite

### 16. Grounding selector

You may have hum or noise in your speaker, put the selector in "Ground" position

### 17. Air cooling windows

This part is the air cooling window. Don't obstruct it.

### 18. Mains Cord



## Operation

### Connecting Power / Circuit Size Requirements.

VA Series amplifier power requirements are rated at:

- a) "Idle"
- b) 1/8th power ("typical" music conditions)
- c) 1/3rd power ("continuous" music conditions)
- d) maximum rated power (circuit breaker limited).

The maximum power current draw rating is limited only by the front panel circuit breaker. Consult the specification in the *Appendices* section for figures on the current that each amplifier will demand. Make sure the mains voltage is correct and is the same as that printed on the rear of the amplifier. Damage caused by connecting the amplifier to improper AC voltage is not covered by any warranty. Unless otherwise specified when ordered, Audiocenter amplifiers shipped to customers are configured as follows:

North America	-	120V AC/60Hz
Europe	-	230V AC/50Hz~60Hz
Asia	-	220V AC/50Hz~60Hz
Australia	-	240V AC/50Hz~60Hz
South America	-	120V AC/60Hz or 220V AC/50Hz
Japan	-	100V AC/50Hz

**NOTE:** Always turn off and disconnect the amplifier from mains voltage before making audio connections. Also, as an extra precaution, have the attenuators turned down during power-up.

### Cooling System and Requirements.

VA Series amplifiers use a twin-tunnel forced-air cooling system to maintain a low, even operating temperature. Drawn in by dual 45 cubic feet-per-minute (CFM) fans on the rear panel, air flows through the cooling fans of the channel heat sinks (dissipating power transistor heat), then exhausts through the front panel slots.

When the amplifier is turned on, the fans briefly "rev up," then slow to an idle; this indicates that the temperature sensing circuits are operating normally. extreme thermal load, the fans will force a very Large volume of air through the heat sinks. If either heat sink surpasses the maximum allowed temperature, the sensing circuit will open the output relay, disconnecting the load from that channel. If the power transformer overheats, another sensing circuit opens both channel output relays until the transformer cools to a safe temperature.

**IMPORTANT:** To ensure optimum cooling, periodically clean the amplifier fan filters (removable without tools). Also make certain that there is enough space around the front of the amplifier to allow the cooling air to escape. If the amplifier is rack-mounted, do not use doors or covers on the front of the rack; the exhaust air must flow out without resistance. If the amplifiers are to be housed in racks with closed backs, allow at least one (1) standard rack space of opening in the front of the rack for every four amplifiers.



### **Connecting Inputs.**

Use XLR input connectors on the rear to supply audio signals to your **Audiocenter** VA Series amplifier. Both connectors accept balanced and unbalanced audio connections. (The VA Series amplifiers are configured standard with "Pin 2 hot" on XLR inputs. Please note that some other **Audiocenter** amplifiers are configured with "Pin 3 hot"). The unused connector can be used to jumper the audio input to another amplifier input. For more information, see the sections on *Balanced XLR Input Connectors*, *Input XLR Polarity*, and *Input Sensitivity*.

### **Connecting Outputs.**

Speakers are connected with Speakon connectors. For more information, see the *Output Connectors* and *Mode Selection* sections.

## **Mode Selection.**

The DIP Mode Select switch (located on the rear panel) configures the amplifier for either Stereo, Parallel or Bridged Mono Mode. Amplifiers are factory-configured for Stereo Mode.

### **Stereo Mode.**

In Stereo Mode, both channels operate independently, with their input attenuators controlling their respective levels. Signal at Channel A's input produces output at Channel A's output, while signal at Channel B's input produces output at Channel B's output. Recommended minimum nominal load impedance for stereo operation is 2 ohms per channel.

### **Parallel Mode.**

When set to Parallel Mode, a signal applied to Channel A's input will be amplified and appear at outputs for both Channels A & B. Input on Channel A.

### **Bridged Mono Mode.**

Bridged Mono Mode straps both amplifier channels together to make a very powerful, single-channel monaural amplifier. One channel "pushes" and the other "pulls" equally, doubling the power over that of either channel alone. Signal is applied to the Channel A input only. Both attenuators are used to control signal level; in addition, both must be adjusted to the same setting.

*NOTE: The channel B input connectors may be used to "loop thru" the channel A signal when in parallel or bridged mono mode.*

*Use extreme caution when operating the amplifier in Bridged Mono Mode. Never ground either side of the speaker cable when the amplifier is in Bridged Mono Mode; both sides are "hot." If an output patch panel is used, all connections must be isolated from each other and from the panel. The recommended minimum nominal load impedance in the Bridged Mono Mode is 4 ohms, which is the equivalent to driving both channels separately at 2 ohms. Driving bridged loads of less than the recommended minimums will activate the LRS™ circuitry, resulting in a loss of power, and may also lead to a thermal protect condition. See figures on pages 9 showing output connection information.*

### Stereo Mode Connections (Speakon Output Connectors)

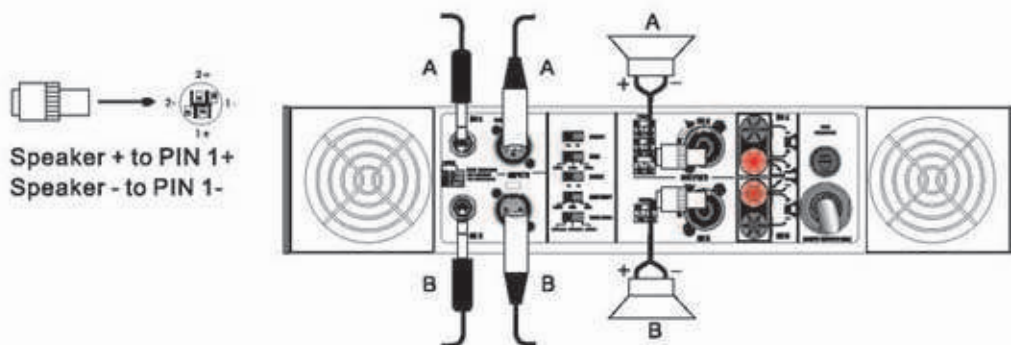

### Parallel Mode Connections (Speakon Output Connectors)

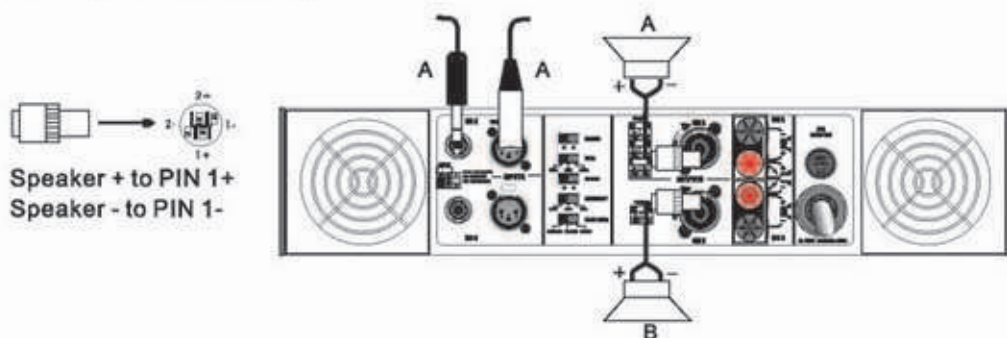

### Bridged Mono Mode Connections (Speakon Output Connectors)

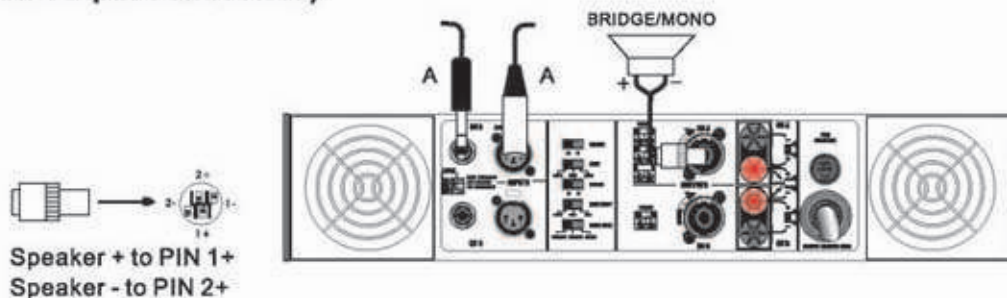



## Protection Features

### LX™ Clip Limiting Protection

At the amplifier's full power limit, or clipping point, LX™ will be activated. This is indicated by illumination of the Limiter LED. The channel gain is automatically reduced, protecting the loudspeakers from potential damage from the high power, continuous square waves that would otherwise be produced. LX™ may be activated by uncontrolled feedback, oscillations, improper equipment gain settings, or an equipment malfunction upstream from the amplifier. Only steady or excessive clipping (not normal program transients) will trigger LX™. The circuit is virtually transparent in operation and full signal bandwidth is maintained.

### IGM Impedance Sensing.

IGM (Instantaneous Gain Modulation) is an innovative circuit that allows the amplifier to operate safely into difficult loads. When the amplifier sees a load that overstresses the output stage, the IGM circuit adjusts the channel gain to a safe level. Like LX™, the IGM circuit is inaudible in normal use. In addition, if extreme and sustained low impedance is encountered, the amplifier's output relay will open.

### Auto Ramp Protection.

Auto Ramp operates every time the amplifier is turned on or is reactivated after a protect condition is corrected. His exclusive ~~Audiocenter~~ feature gradually increases gain to the attenuator setting avoiding unnecessary stress on the loudspeakers.

### Thermal Protection.

Abnormally high heat sink temperatures will engage the Protect circuit for the overheating channel only. (An output relay disconnects the loudspeakers until nominal temperature range is restored.) During this time, the Protect LED will light. If the power transformer gets too hot, its thermal sensing circuit will disconnect both channel outputs. During this time, the Active LED will extinguish, the Protect and Clip LEDs will Stay lit, and the cooling fan will continue running at low speed. Normal operation resumes once the transformer cools to a safe level.

### LRS™ Short Circuit Protection.

If an output is shorted (i.e., defective speakers or crossed speaker wires) the LRS™ and thermal circuits will automatically protect the amplifier. The LRS™ circuit senses the short circuit as an extremely stressful load condition and attenuates the signal, protecting the channel's output transistors from over-current stress. If the short circuit remains, the load will be disconnected by the thermal protection circuitry (output relay Opens). And the amplifier will be locked. You need to remove the short circuit, shut down the amplifier and turn on again to restart the amplifier.

### DC Voltage Protection.

If an amplifier channel detects DC voltage at its output terminals, the output relay will immediately open to prevent loudspeaker damage. The Protect LEDs will light.

### Subsonic Frequencies.

Built-in high pass filtering provides subsonic frequency protection for each channel. In addition, a relay will open if excessive subsonic energy appears at the output.

## User Precautions

### Speaker Protection

All loudspeakers have electrical, thermal, and physical limits which must be observed to prevent damage or failure. Cone or compression drivers can be damaged (sometimes to the point of failure) from excessive power, low frequencies applied to high frequency drivers, severely clipped waveforms, and DC voltage. All VA Series amplifiers automatically protect speakers from DC voltages and subsonic signals. For more information, see the *TourClass Protection* section.

Mid- and high-frequency transducers-compression driver in particular-are highly susceptible to damage from overpowering, clipped waveforms, or frequencies below their rated passband. When using an electronic crossover, make absolutely certain that the low and mid bands are connected to the correct amplifiers and drivers-and not accidentally connected to those for a higher or lower frequency band.

The amplifier's clipping point is its maximum peak output power. At maximum peak output power, Audiocenter VA Series amplifiers will deliver more power than many speakers can safely handle. Be sure the peak power capability of the amplifier is not excessive for your speaker system. To ensure that the speakers never receive excessive power, and to prevent amplifier clipping, use a properly adjusted external limiter (or a compressor with a ratio of 10:1 or higher) to control power output. Use one compressor/limiter for each frequency band in systems with active electronic crossovers.

The LX™ clip limiting circuit will automatically limit the duration of squared-off, continuous waveforms applied to the speakers. The amplifier will, however, allow normal musical transient bursts to pass. Of course, when the amplifier does clip, it is operating at its maximum output power. Note that some speaker systems are packaged with proprietary "processors" that have power limiting circuits and therefore should not require additional limiting.

Do not drive any low-frequency speaker enclosure with frequencies lower than its own tuned frequency. The reduced acoustical damping could cause a ported speaker to "bottom out" even at moderate power. Consult the speaker system specifications to determine its frequency limits, and employ a roll-off filter if necessary.

### Recommended Speaker Cabling

The wire gauge charts will assist you in determining the optimum copper wire gauge for your speaker cables. Remember that the speaker cable resistance robs amplifier power in two ways: through power lost directly to resistance (often referred to as  $i^2R$  loss), and through increased total load resistance, which decreases the amount of power available from the amplifier. The charts (Appendix C) give cable length figures in feet/AWG wire gauges and in metric values.



### **Maintenance**

A VA Series amplifier requires no routine maintenance other than occasional cleaning or replacement of the fan intake filters on the rear of the amplifier. (This operation does not require any tools). Filters must be kept clear and clean to ensure proper ventilation through the unit. If the amplifier is used in an extremely dusty or smoky environment, the filters should be cleaned or changed frequently and the unit should be periodically "blown free" (using compressed air) of any foreign matter that may have penetrated through the filter.

Users will not need to make any internal adjustments to the amplifier during its lifetime. There are no user serviceable parts or adjustments that require opening the power amplifier. Cover removal exposes the risk of shock, so refer all servicing to qualified service technicians authorized by **AUDIOCENTER**.

### **User Responsibility**

Your VA Series amplifier is very powerful and can be potentially dangerous to loudspeakers and operators alike. It is your responsibility to read the section titled "Important Precautions" and make sure that the amplifier is installed, wired, and operated properly as instructed in this manual. Many loudspeakers can be easily damaged or destroyed by overpowering, especially with the high power available from a bridged amplifier. Read the section on Speaker Protection and always be aware of the speaker's continuous and peak power capabilities. **AUDIOCENTER** is not responsible for damage to loudspeakers for any reason.

### **Service and Repair**

In the unlikely event that your amplifier develops a problem, it must be returned to an authorized distributor, service center or shipped directly to our factory. To obtain service, contact your nearest **AUDIOCENTER** Service Center, Distributor, Dealer, or any of the worldwide **AUDIOCENTER** offices.

Because of the complexity of the design and the risk of electrical shock, all repair should be attempted only by qualified technical personnel. If the unit needs to be shipped back to the factory, it must be sent in its original carton. If improperly packed, your amplifier may be damaged.

For those with Internet access, please visit the **AUDIOCENTER** website at: <http://www.ac-pro.net>



# ***Appendices***

## Appendix A - Amplifier Specifications

Specifications		VA201	VA401	VA601	VA801	VA901	VA1201
Maximum Output Power	4Ω bridge	/	5600W	8400W	9100W	9450W	18900W
	8Ω bridge	1330W	4200W	8300W	7350W	8400W	12800W
	2Ω stereo	/	2×2800W	2×4200W	2×4550W	2×5250W	2×8750W
	4Ω stereo	2×665W	2×2100W	2×3150W	2×3675W	2×4200W	2×6300W
	8Ω stereo	2×445W	2×1400W	2×2100W	2×2450W	2×2800W	2×4200W
Rated Power (20Hz-20KHz, <0.1%THD)	4Ω bridge	/	1600W	2400W	2600W	3100W	5400W
	8Ω bridge	380W	1200W	1800W	2100W	2500W	3600W
	2Ω stereo	/	2×800W	2×1200W	2×1300W	2×1500W	2×2000W
	4Ω stereo	2×190W	2×600W	2×900W	2×1050W	2×1250W	2×1800W
	8Ω stereo	2×130W	2×400W	2×600W	2×700W	2×800W	2×1200W
A-Guard Protection System	DC protection	✓					
	Short circuit protection	✓					
	Smart overheat management	✓					
	Overheat protection	✓					
	Input overload protection	✓					
	Output overload protection	✓					
	Soft startup protection	✓					
Limiter protection	Up to 9V						
Frequency Response(1W 8Ω stereo)	20Hz-20KHz(±0.5dB)						
Sensitivity	0.775V / 32dB / 26dB			0.775V / 36dB / 32dB			
Connectors	Input	Neutrik® female XLR&Jack					
	Output	Neutrik® Speakon NLT4MP&Binding post					
Filter Capacitor Capacity	4700µf/83V×4	10000µf/83V×4	10000µf/83V×8	10000µf/80V×8		6800µf/100V×12	
Input Impedance	Balanced	20KΩ					
	Unbalanced	10KΩ					
Crosstalk(20Hz-20KHz, Rated power 8Ω)	>60dB						
S/N Ratio (Rated power 8Ω, A weighted)	≥103dB						
Damping Factor(1KHz&8Ω)	≥150		≥350			≥650	
Intermodulation Distortion(20Hz-20KHz, half power)	≤0.1%						
Total Harmonic Distortion(8Ω&20Hz-20KHz, half power)	≤0.1%						
Phase Response(1W&8Ω, 20Hz-20KHz)	+4° -12°				+5° -20°		
Slew Rate	≥25V/µs						
Output Circuitry	CLASS AB				CLASS H*		
Power Consumption(Dual channel driven 4Ω, 1/8RMS/230V)	1.1A	3.1A	3.4A	4.3A	4.5A	5.0A	
Rack Space	1U	2U			3U		
Cooling	Back to front venting, mandatory cooling						
Dimensions(W×H×D)	483x44x365mm		483x88x451mm			483x132x484mm	
Net Weight	11.0Kg	18.0Kg	20.0Kg	21.5Kg	35.0Kg	40.0Kg	
Technical Support and After-sales Service	Global application support team						



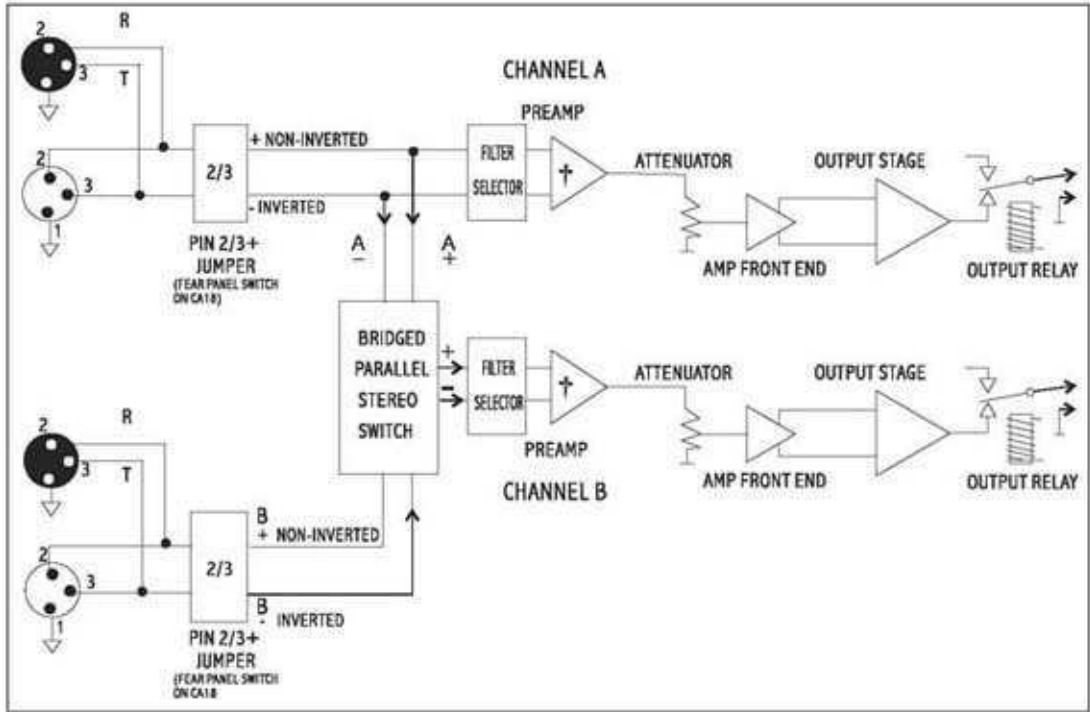

### Appendix C - Wire Gauge Chart (Metric)

Stranded Cable Lgth. (m)	Wire Gauge (mm <sup>2</sup> )	Power Loss (8 ohm load)	Power Loss (4 ohm load)	Power Loss (2 ohm load)
2	0.3	(8 ohm load)	(4 ohm load)	(2 ohm load)
	0.5	2.9%	5.6%	10.8%
	0.75	1.74	3.4	6.7
	1.5	1.16	2.3	4.5
	2.5	0.58	1.16	2.3
	4	0.35	0.70	1.39
5	0.5	0.22	0.44	0.87
	0.75	4.3%	8.2%	15.5%
	1.5	2.9	5.6	10.8
	2.5	1.45	2.9	5.6
	4	0.87	1.74	3.4
	6	0.55	1.09	2.2
10	0.5	0.37	0.73	1.45
	0.75	8.24%	15.5%	28%
	1.5	5.6	10.8	19.9
	2.5	2.9	5.6	10.8
	4	1.74	2.9	6.7
	6	1.09	1.74	4.3
30	0.75	0.73	1.09	2.9
	1.5	15.5%	0.73%	45%
	2.5	8.2	15.5	28
	4	5.1	9.8	18.2
	6	3.2	6.3	12.0
	10	2.2	4.3	8.2
		1.31	2.6	5.1

Stranded Cable Lgth. (ft.)	Wire Gauge (AWG)	Power Loss	Power Loss	Power Loss
5	18	(8 ohm load)	(4 ohm load)	(2 ohm load)
	16	0.81%	1.61%	3.2%
	14	0.51	1.02	2.0
	12	0.32	0.64	1.28
	10	0.20	0.40	0.80
10	18	0.128	0.25	0.51
	16	1.61%	3.2%	6.2%
	14	1.02	2.0	4.0
	12	0.64	1.28	2.5
	10	0.40	0.80	1.60
40	18	0.25	0.51	1.01
	16	6.2%	11.9%	22%
	14	4.0	7.7	14.6
	12	2.5	5.0	9.6
	10	1.60	3.2	6.2
	8	1.01	2.0	4.0
80	18	0.60	1.20	2.4
	16	11.9%	22%	37%
	14	7.7	14.6	26
	12	5.0	9.6	17.8
	10	3.2	6.2	11.8
	8	2.0	4.0	7.7
			1.20	2.4



**AUDIOCENTER © Dynamic Audio Solutions**