

Gooseneck Microphones

HCS-1857C Series Cardioid Condenser Gooseneck Microphone		11.2
HCS-1857C13	Cardioid Condenser Gooseneck Microphone	11.2
HCS-1857C15	Cardioid Condenser Gooseneck Microphone	11.2
HCS-1857C18	Cardioid Condenser Gooseneck Microphone	11.2
HCS-1857C21	Cardioid Condenser Gooseneck Microphone	11.3
HCS-1857C24	Cardioid Condenser Gooseneck Microphone	11.3
HCS-1857A Series Tabletop Microphone Stand		11.4
HCS-1857A	Tabletop Microphone Stand	11.4
HCS-1857AN	Tabletop Microphone Stand (with non-lock button)	11.5
HCS-1857AS	Tabletop Microphone Stand (with self-lock button)	11.6
HCS-1857B Series Tabletop Microphone Stand		11.7
HCS-1857B	Tabletop Microphone Stand	11.7
HCS-1857BN	Tabletop Microphone Stand (with non-lock button)	11.8
HCS-1857BS	Tabletop Microphone Stand (with self-lock button)	11.9

HCS-1857C Series Cardioid Condenser Gooseneck Microphone

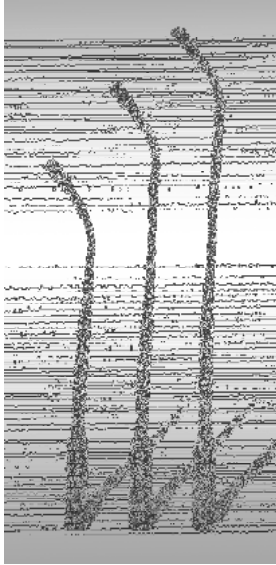

Features

- Stylish and ergonomic design
- For quality sound reinforcement, professional recording, television, conference and other demanding sound pickup applications
- The small diameter double-gooseneck design permits highly flexible positioning while maintaining a smooth, wellcontoured appearance
- An included snap-on foam windscreen effectively reduces wind and pop noise
- Uni-directional electret condenser microphone
- Excellent immunity to RF interference from mobile phones and comparable devices
- Built-in microphone power supply and amplifier components can be powered from any external 11 V to 52 V DC phantom power supply
- Flat frequency response when switch is set to "—" position. When switch is set to "∩" position the built-in high-quality low-frequency attenuation circuit cuts-off at 80 Hz, reducing airflow noise when speaking close to the microphone. Reduces pick-up of low-frequency ambient noise (such as traffic, air-conditioning system, etc.), room echo and the sound of mechanical vibrations
- Simple and rapid installation. The microphone terminal is a standard 3-pin XLRM-type connector, which can be connected to any 3-pin XLRF-type socket or directly to the sound mixing console
- Low-impedance balanced audio output, audio signals output from Pins 2 and 3 of XLRM-type connector (Pin 2 is positive phase level, Pin 3 is negative phase level), while Pin 1 is for the ground (shield) connection

Technical Specifications

Electrical

Element..... Electret condenser microphone
 Polar pattern..... Cardioid unidirectional
 Sensitivity..... -40 dBV/Pa
 Frequency response..... 30 Hz~20 kHz
 Low-frequency attenuation..... 80 Hz, -18 dB/Max
 Output impedance..... 280 Ω
 Maximum sound pressure..... 139 dB, THD<1%
 SNR..... >90 dB
 Phantom power requirements..... 11 V~ 52 V DC, 2 mA
 Switch..... Flat, low frequency attenuation
 Output connector..... 3-pin XLRM-type connector

Mechanical

Dimensions..... HCS-1857C13: 330.2 mm – long
 HCS-1857C15: 381.0 mm – long
 HCS-1857C18: 457.2 mm - long
 Head diameter: 12.0 mm
 Weight..... HCS-1857C13: 146 g
 HCS-1857C15: 150 g
 HCS-1857C18: 156 g
 Accessory..... foam windscreen

Polar pattern

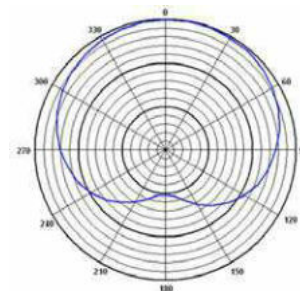

Frequency response

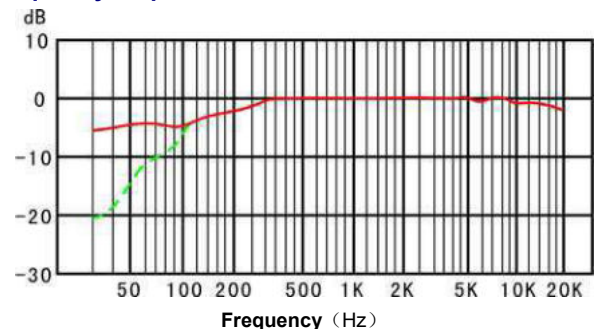

Ordering Information

HCS-1857C13..... Cardioid Condenser Gooseneck Microphone
 HCS-1857C15..... Cardioid Condenser Gooseneck Microphone
 HCS-1857C18..... Cardioid Condenser Gooseneck Microphone

HCS-1857C Series Cardioid Condenser Gooseneck Microphone



Features

- Stylish and ergonomic design
- For quality sound reinforcement, professional recording, television, conference and other demanding sound pickup applications
- The small diameter double-gooseneck design permits highly flexible positioning while maintaining a smooth, wellcontoured appearance
- An included snap-on foam windscreen effectively reduces wind and pop noise
- Uni-directional electret condenser microphone
- Excellent immunity to RF interference from mobile phones and comparable devices

- Built-in microphone power supply and amplifier components can be powered from any external 11 V to 52 V DC phantom power supply
- Flat frequency response when switch is set to "—" position. When switch is set to "∟" position the built-in high-quality low-frequency attenuation circuit cuts-off at 80 Hz, reducing airflow noise when speaking close to the microphone. Reduces pick-up of low-frequency ambient noise (such as traffic, air-conditioning system, etc.), room echo and the sound of mechanical vibrations
- Simple and rapid installation. The microphone terminal is a standard 3-pin XLRM-type connector, which can be connected to any 3-pin XLRF-type socket or directly to the sound mixing console
- Low-impedance balanced audio output, audio signals output from Pins 2 and 3 of XLRM-type connector (Pin 2 is positive phase level, Pin 3 is negative phase level), while Pin 1 is for the ground (shield) connection

Technical Specifications

Electrical

Element.....Electret condenser microphone
 Polar pattern.....Cardioid unidirectional
 Sensitivity.....-40 dBV/Pa
 Frequency response.....30 Hz~20 kHz
 Low-frequency attenuation.....80 Hz, -18 dB/Max
 Output impedance.....280 Ω
 Maximum sound pressure.....139 dB, THD<1%
 SNR.....>90 dB
 Phantom power requirements.....11 V~ 52 V DC, 2 mA
 Switch.....Flat, low frequency attenuation
 Output connector.....3-pin XLRM-type connector

Mechanical

Dimensions.....HCS-1857C21: 533.4 mm – long
HCS-1857C24: 609.6 mm – long
Head diameter: 12.0 mm
 Weight.....HCS-1857C21: 161 g
HCS-1857C24: 166 g
 Accessory.....foam windscreen

Polar pattern

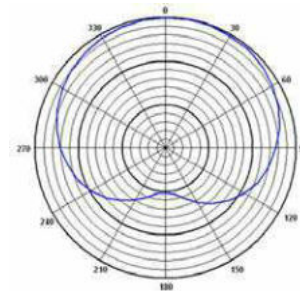

Frequency response

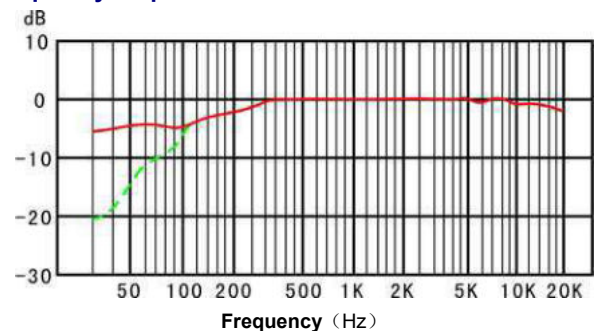

Ordering Information

HCS-1857C21.....Cardioid Condenser Gooseneck Microphone
 HCS-1857C24.....Cardioid Condenser Gooseneck Microphone

HCS-1857A Tabletop Microphone Stand



Features

- Delicate and elegant structural design, ergonomic and highly modern
- 3-pin XLRF-type socket as microphone input; 3-pin XLRM-type socket on the rear as microphone signal output
- It can be widely used in meetings, lectures, teaching and on other occasions when cooperating with gooseneck microphone
- Complementary to other 3-pin XLRM-type microphone devices

Technical Specifications

Electrical

Input connector.....3 pin XLRF-type
 Output connector.....3 pin XLRM-type
 Phantom power requirements.....24 V~ 48 V DC, 3 mA
 Insertion loss.....1 dB (150 Ω input resistance)
 Output impedance.....380 Ω

Mechanical

Installation.....Tabletop
 Dimensions (h x w x d).....41 x 91 x 131 mm
 Weight.....808 g
 Color.....Black

Configuration and connection

1. Connecting microphone: Connecting 3-pin XLRM-type connector at the bottom of the microphone to the 3-pin XLRF-type socket on the microphone stand.

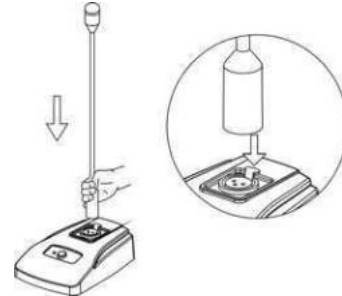

2. Connecting amplifier: Connecting 3-pin XLRM-type connector to other devices such as amplifier, audio mixing console, etc.

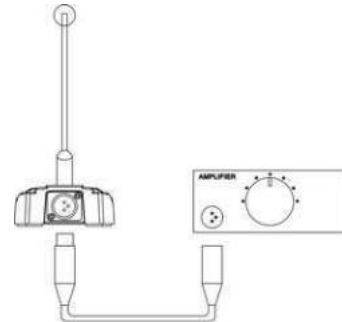

3. Microphone detachment: Press the release tab of the XLR socket on the microphone stand and pull out the microphone.

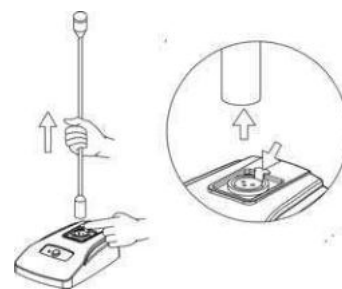

Ordering Information

HCS-1857A.....Tabletop Microphone Stand

HCS-1857AN Tabletop Microphone Stand



Features

- Delicate and elegant structural design, ergonomic and highly modern
- 3-pin XLR-type socket as microphone input; 3-pin XLRM-type socket on the rear as microphone signal output
- It can be widely used in meetings, lectures, teaching and on other occasions when cooperating with gooseneck microphone
- Complementary to other 3-pin XLRM-type microphone devices
- HCS-1857AN with mute (MUTE) key. When pressing the MUTE button, the red LED indicator lights up and the microphone is muted; release the MUTE button to activate the microphone again. The MUTE key can be repeatedly pressed to freely control the microphone. The attenuation value is 55 dB at 1 kHz

Technical Specifications

Electrical

Input connector	3 XLRF-type
Output connector	3 XLRM-type
Indicator light	MUTE key with red LED
Phantom power requirements	24 V~ 48 V DC, 3 mA
Insertion loss	1 dB (150 Ω input resistance)
Output impedance	380 Ω
Mute attenuation (150 Ω input resistance)	55 dB at 1 kHz
	35 dB at 100 Hz
	30 dB at 50 Hz

Mechanical

Installation	Tabletop
Dimensions (h x w x d)	41 x 91 x 131 mm
Weight	808 g
Color	Black

Configuration and connection

1. Connecting microphone: Connecting 3-pin XLRM-type connector at the bottom of the microphone to the 3-pin XLRF-type socket on the microphone stand.

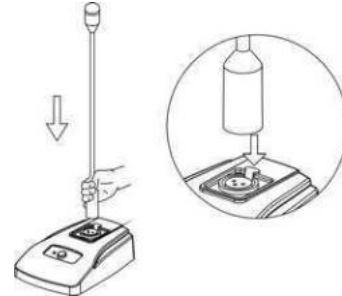

2. Connecting amplifier: Connecting 3-pin XLRM-type connector to other devices such as amplifier, audio mixing console, etc.

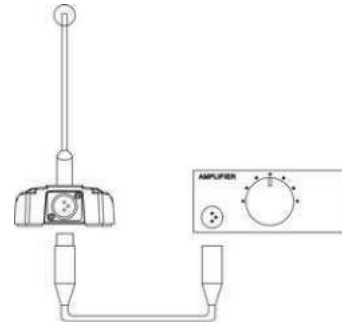

3. Microphone detachment: Press the release tab of the XLR socket on the microphone stand and pull out the microphone.

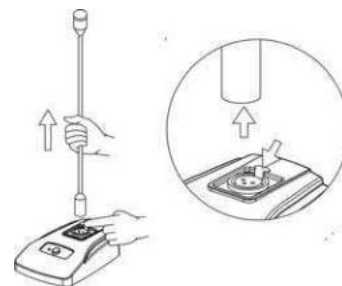

Ordering Information

HCS-1857AN...Tabletop Microphone Stand (with non-lock button)

HCS-1857AS Tabletop Microphone Stand



Features

- Delicate and elegant structural design, ergonomic and highly modern
- 3-pin XLR-type socket as microphone input; 3-pin XLRM-type socket on the rear as microphone signal output
- It can be widely used in meetings, lectures, teaching and on other occasions when cooperating with gooseneck microphone
- Complementary to other 3-pin XLRM-type microphone devices
- HCS-1857AS with ON/OFF key. When pressing the ON/OFF button, the red LED indicator lights up, and the microphone is activated, press ON/OFF button again to turn off the microphone. The attenuation value is 55 dB at 1 kHz

Technical Specifications

Electrical

Input connector	3 XLRF-type
Output connector	3 XLRM-type
Indicator light	ON/OFF key with red LED
Phantom power requirements	24 V~ 48 V DC, 3 mA
Insertion loss	1 dB (150 Ω input resistance)
Output impedance	380 Ω
Turn off attenuation (150 Ω input resistance)	55 dB at 1 kHz
	35 dB at 100 Hz
	30 dB at 50 Hz

Mechanical

Installation	Tabletop
Dimensions (h x w x d)	41 x 91 x 131 mm
Weight	808 g
Color	Black

Configuration and connection

1. Connecting microphone: Connecting 3-pin XLRM-type connector at the bottom of the microphone to the 3-pin XLRF-type socket on the microphone stand.

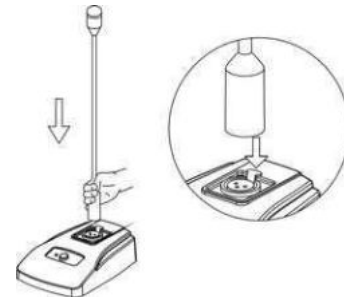

2. Connecting amplifier: Connecting 3-pin XLRM-type connector to other devices such as amplifier, audio mixing console, etc.

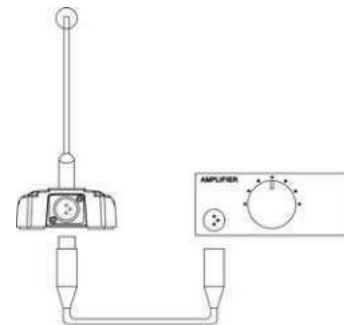

3. Microphone detachment: Press the release tab of the XLR socket on the microphone stand and pull out the microphone.

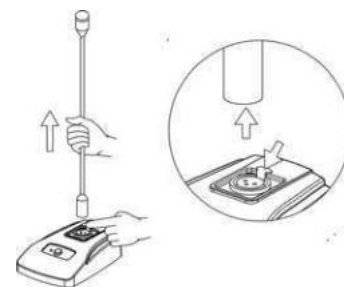

Ordering Information

HCS-1857AS.....Tabletop Microphone Stand (with self-lock button)

HCS-1857B Tabletop Microphone Stand



Features

- Delicate and elegant structural design, ergonomic and highly modern
- 3-pin XLRF-type socket as microphone input; 3-pin XLRM-type connector with 2-meter long cable on the rear as microphone signal output
- It can be widely used in meetings, lectures, teaching and on other occasions when cooperating with gooseneck microphone
- Complementary to other 3-pin XLRM-type microphone devices

Technical Specifications

Electrical

Input connector.....3 XLRF-type
 Output connector.....3 XLRM-type with 2-meter long cable
 Phantom power requirements.....24 V~ 48 V DC, 3 mA
 Insertion loss.....1 dB (150 Ω input resistance)
 Output impedance.....380 Ω

Mechanical

Installation.....Tabletop
 Dimensions (h x w x d).....41 x 112 x 140 mm
 Weight.....820 g
 Color.....Black

Configuration and connection

1. Connecting microphone: Connecting 3-pin XLRM-type connector at the bottom of the microphone to the 3-pin XLRF-type socket on the microphone stand.

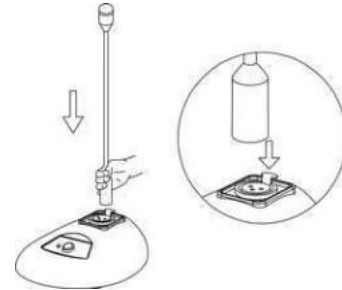

2. Connecting amplifier: Connecting 3-pin XLRM-type connector to other devices such as amplifier, audio mixing console, etc.

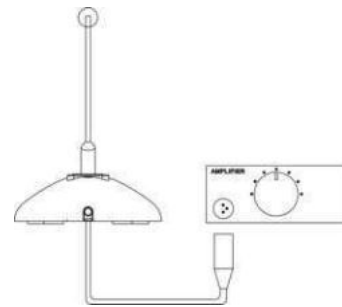

3. Microphone detachment: Press the release tab of the XLR socket on the microphone stand and pull out the microphone.

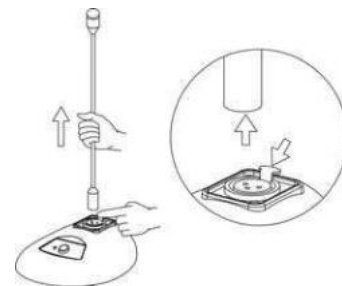

Ordering Information

HCS-1857B.....Tabletop Microphone Stand

HCS-1857BN Tabletop Microphone Stand



Features

- Delicate and elegant structural design, ergonomic and highly modern
- 3-pin XLRF-type socket as microphone input; 3-pin XLRM-type connector with 2-meter long cable on the rear as microphone signal output
- It can be widely used in meetings, lectures, teaching and on other occasions when cooperating with gooseneck microphone
- Complementary to other 3-pin XLRM-type microphone devices
- HCS-1857 BN with mute (MUTE) key. When pressing the MUTE button, the red LED indicator lights up and the microphone is muted; release the MUTE button to activate the microphone again. The MUTE key can be repeatedly pressed to freely control the microphone. The attenuation value is 55 dB at 1 kHz

Technical Specifications

Electrical

Input connector	3 XLRF-type
Output connector	3 XLRM-type with 2-meter long cable
Indicator light	MUTE switch with red LED
Phantom power requirements	24 V~ 48 V DC, 3 mA
Insertion loss	1 dB (150 Ω input resistance)
Output impedance	380 Ω
Mute attenuation (150 Ω input resistance)	55 dB at 1 kHz
	35 dB at 100 Hz
	30 dB at 50 Hz

Mechanical

Installation	Tabletop
Dimensions (h x w x d)	41 x 112 x 140 mm
Weight	820 g
Color	Black

Configuration and connection

1. Connecting microphone: Connecting 3-pin XLRM-type connector at the bottom of the microphone to the 3-pin XLRF-type socket on the microphone stand.

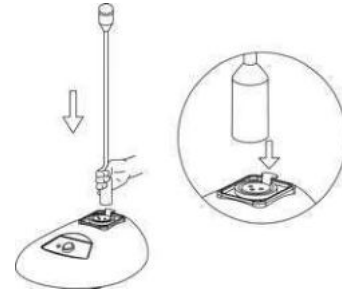

2. Connecting amplifier: Connecting 3-pin XLRM-type connector to other devices such as amplifier, audio mixing console, etc.

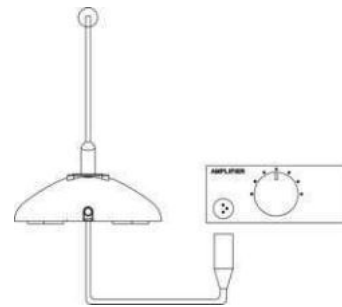

3. Microphone detachment: Press the release tab of the XLR socket on the microphone stand and pull out the microphone.

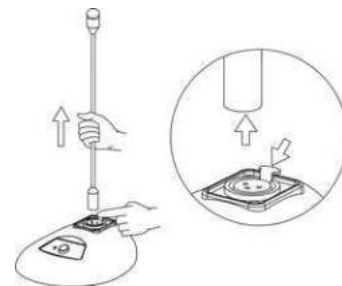

Ordering Information

HCS-1857BN... Tabletop Microphone Stand (with non-lock button)

HCS-1857BS Tabletop Microphone Stand



Features

- Delicate and elegant structural design, ergonomic and highly modern
- 3-pin XLR-type socket as microphone input; 3-pin XLRM-type connector with 2-meter long cable on the rear as microphone signal output
- It can be widely used in meetings, lectures, teaching and on other occasions when cooperating with gooseneck microphone
- Complementary to other 3-pin XLRM-type microphone devices
- HCS-1857BS with ON/OFF key. When pressing the ON/OFF button, the red LED indicator lights up, and the microphone is activated, press ON/OFF button again to turn off the microphone. The attenuation value is 55 dB at 1 kHz

Technical Specifications

Electrical

Input connector	3 XLRF-type
Output connector	3 XLRM-type with 2-meter long cable
Indicator light	MUTE switch with red LED
Phantom power requirements	24 V~ 48 V DC, 3 mA
Insertion loss	1 dB (150 Ω input resistance)
Output impedance	380 Ω
Turn off attenuation (150 Ω input resistance)	55 dB at 1 kHz
	35 dB at 100 Hz
	30 dB at 50 Hz

Mechanical

Installation	Tabletop
Dimensions (h x w x d)	41 x 112 x 140 mm
Weight	820 g
Color	Black

Configuration and connection

1. Connecting microphone: Connecting 3-pin XLRM-type connector at the bottom of the microphone to the 3-pin XLRF-type socket on the microphone stand.

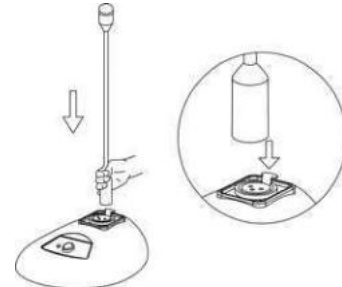

2. Connecting amplifier: Connecting 3-pin XLRM-type connector to other devices such as amplifier, audio mixing console, etc.

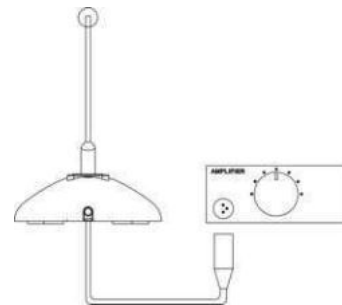

3. Microphone detachment: Press the release tab of the XLR socket on the microphone stand and pull out the microphone.

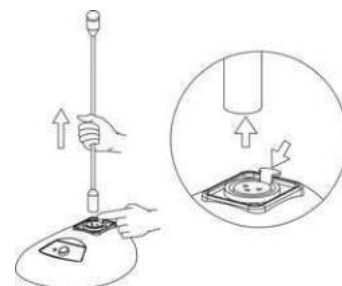

Ordering Information

HCS-1857BS.....Tabletop Microphone Stand (with self-lock button)